

РЕКОМЕНДАЦІЇ

з монтажу фальц-настилу

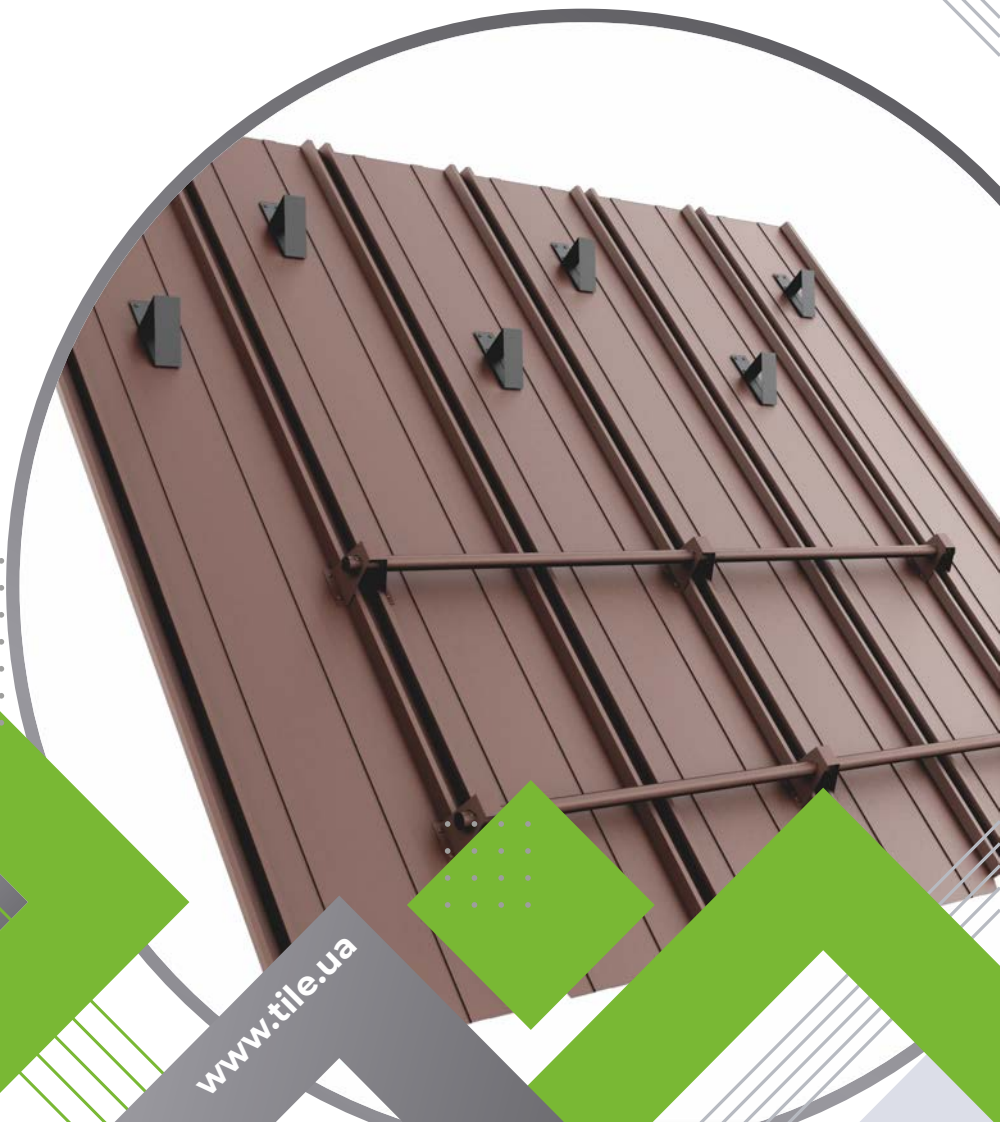

ХВИЛЯ

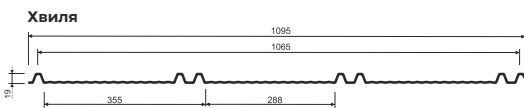
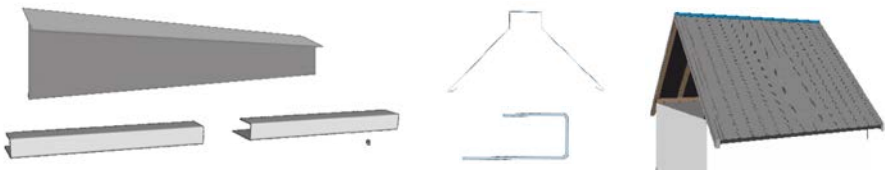
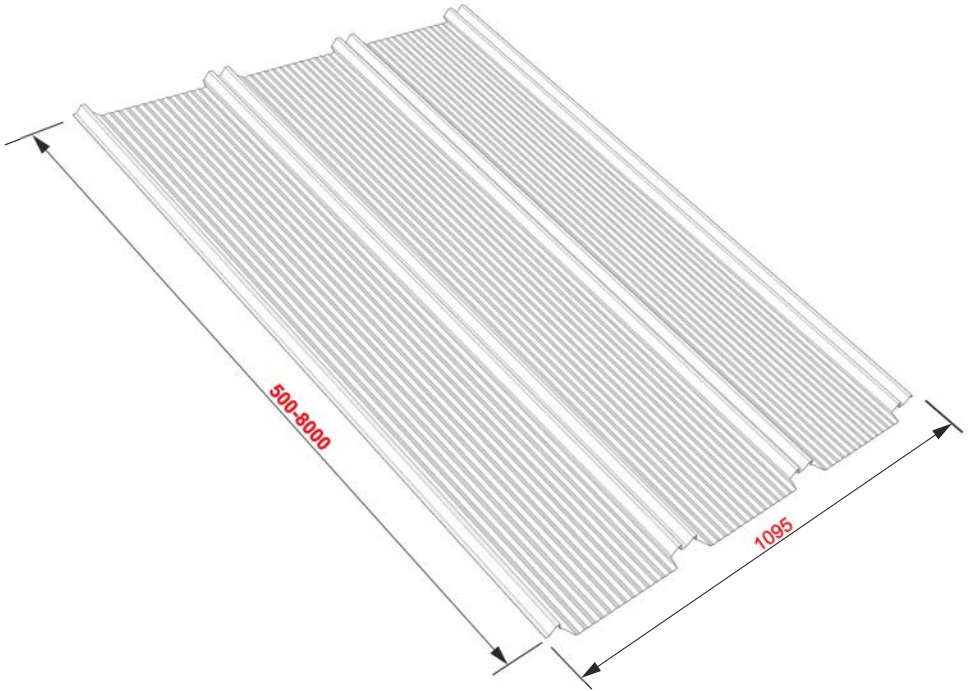

Технічні характеристики	
Загальна ширина, мм	1095
Корисна ширина, мм	1065
Діапазон довжини листів, мм*	500-8000
Рекомендована довжина, мм**	4000
Висота профіля, мм	19
Товщина, мм*	0.40-0.60

* - визначається умовами замовлення
 ** - для збільшення цілісності геометричних параметрів при транспортуванні та монтажі

ТРАПЕЦІЯ

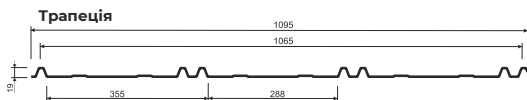
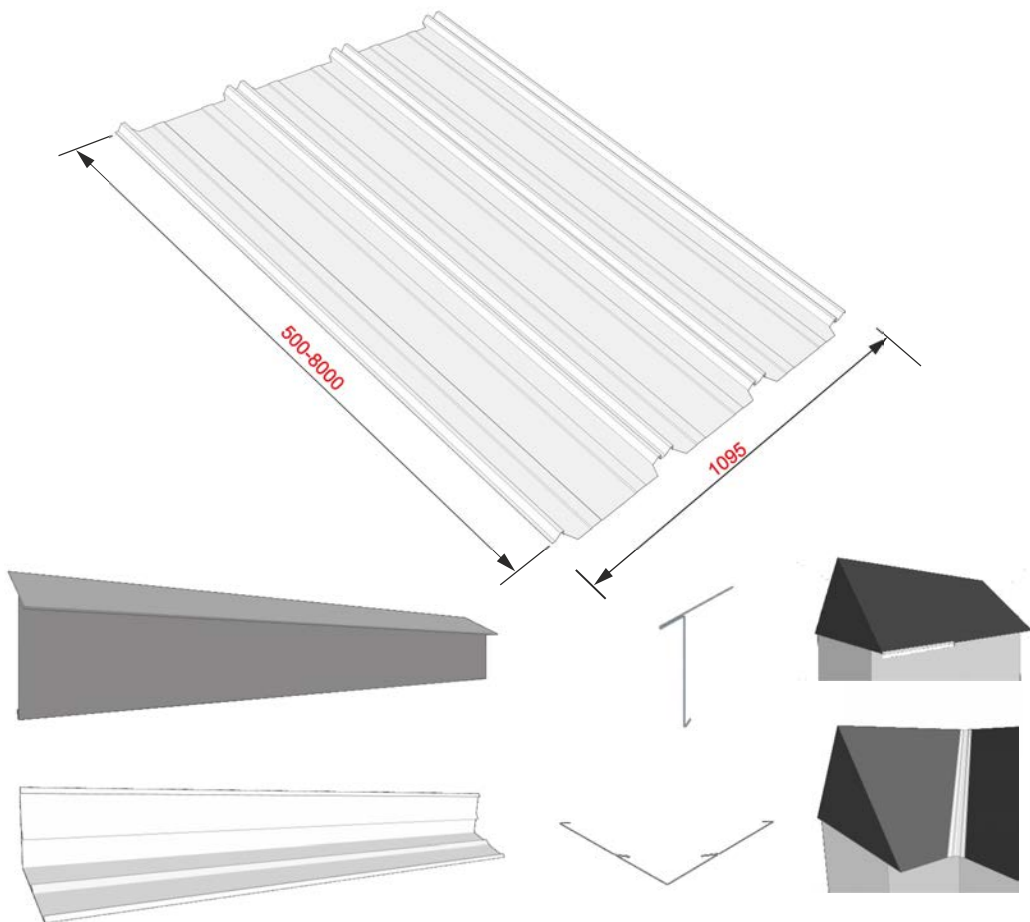

Технічні характеристики	
Загальна ширина, мм	1095
Корисна ширина, мм	1065
Діапазон довжини листів, мм*	500-8000
Рекомендована довжина, мм**	4000
Висота профіля, мм	19
Товщина, мм*	0.40-0.60

* - визначається умовами замовлення
 ** - для збільшення цілісності геометричних параметрів при транспортуванні та монтажі

Рекомендації з монтажу фальц-настилу

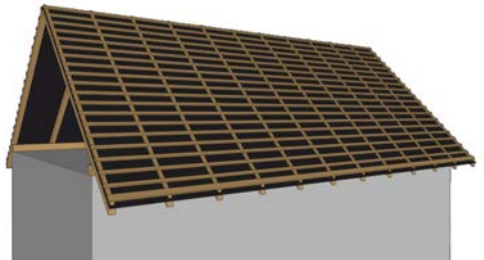
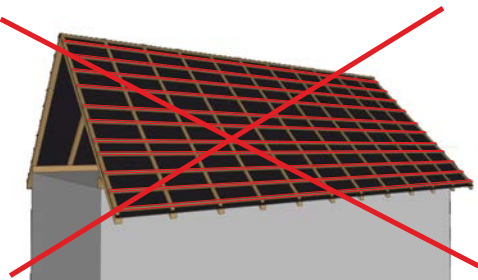
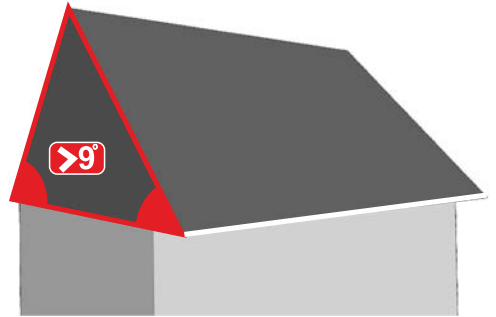
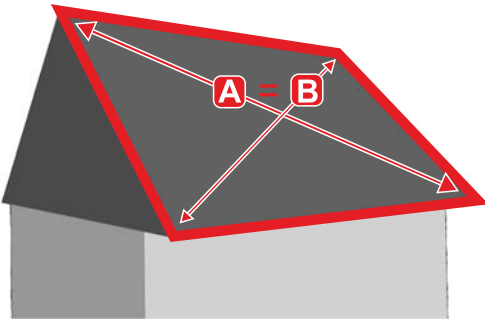
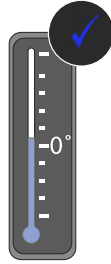
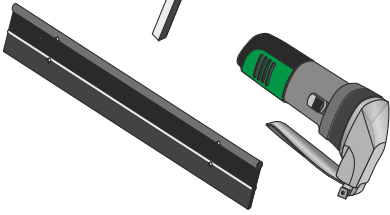
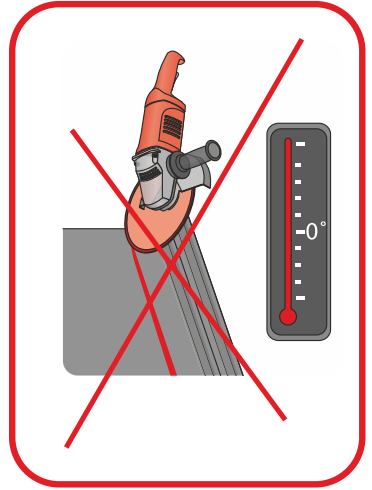
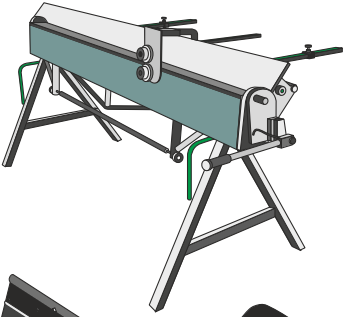

Рекомендації з монтажу фальц-настилу

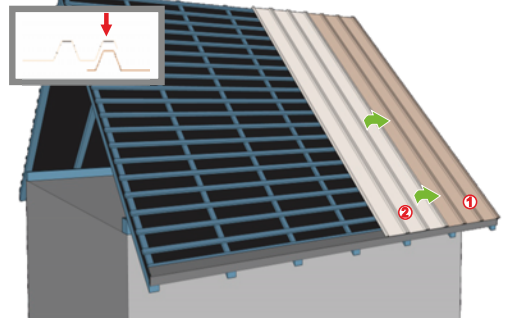
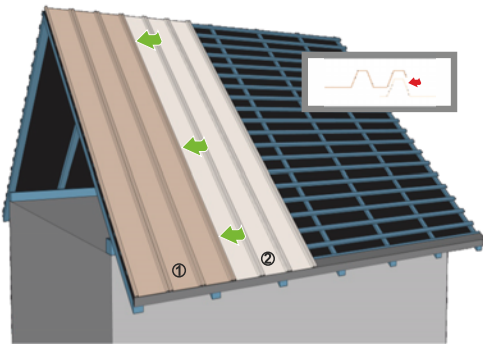
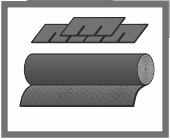
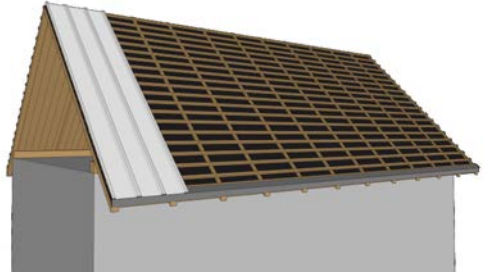
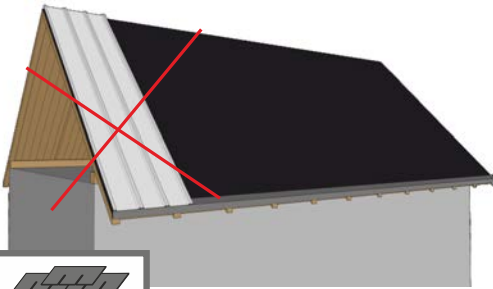
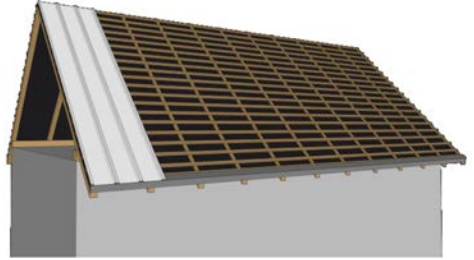
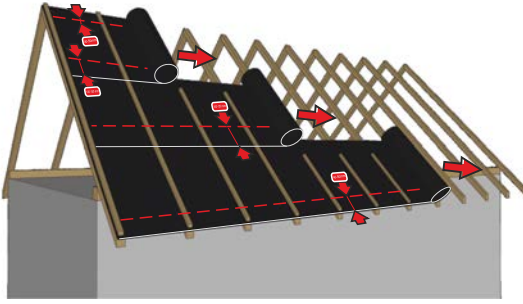

Рекомендації з монтажу фальц-настилу

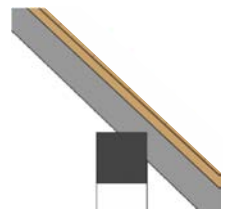
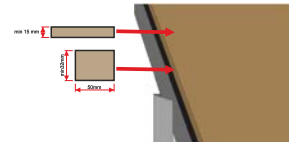
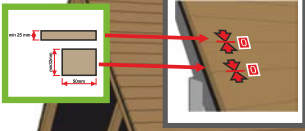
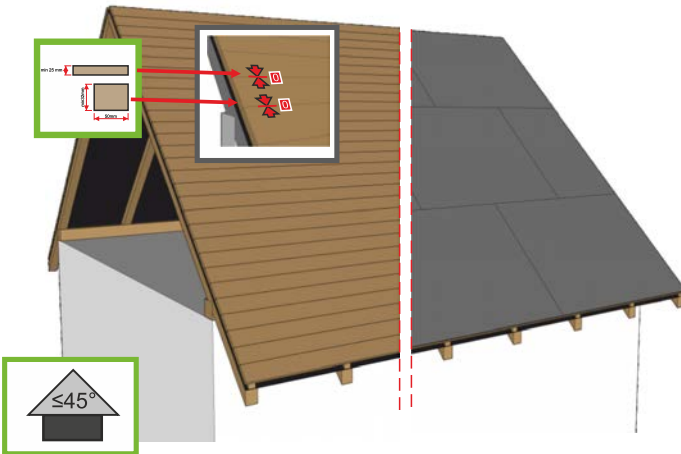
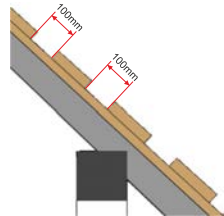
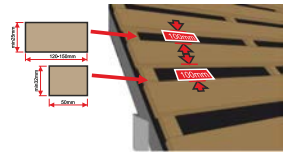
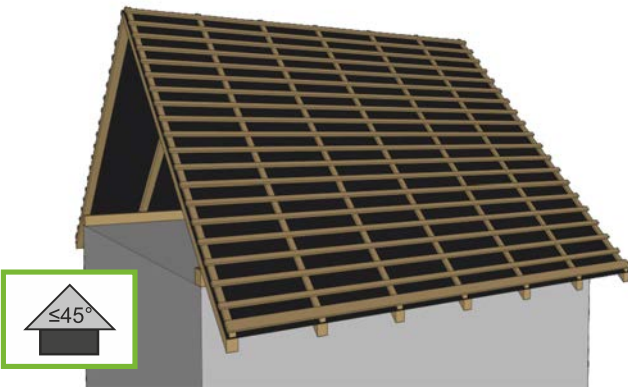
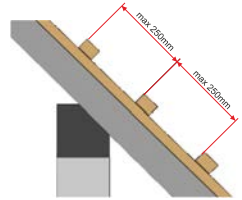
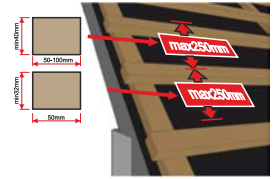
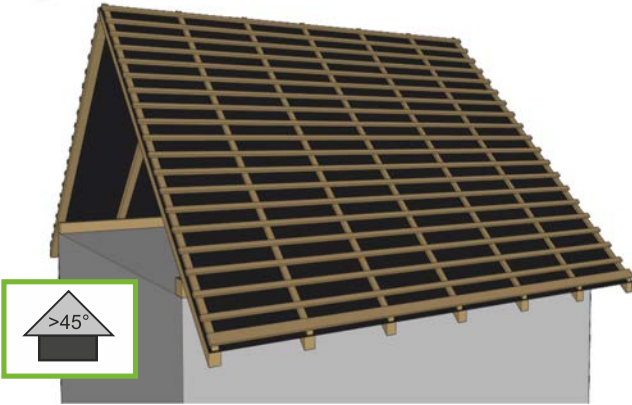

Рекомендації з монтажу фальц-настилу

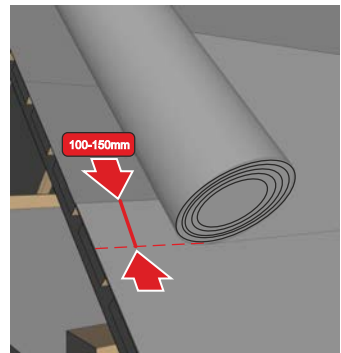
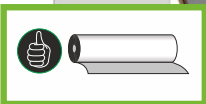
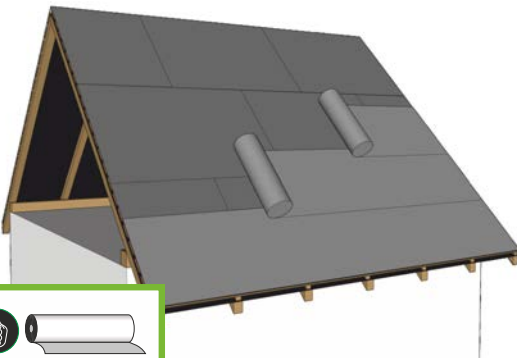
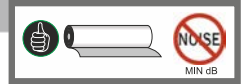
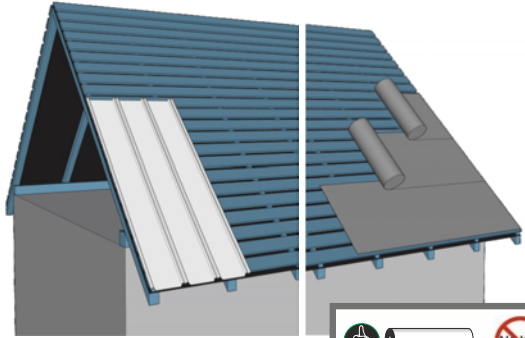
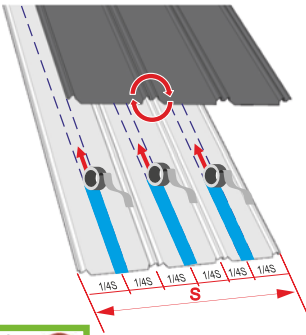
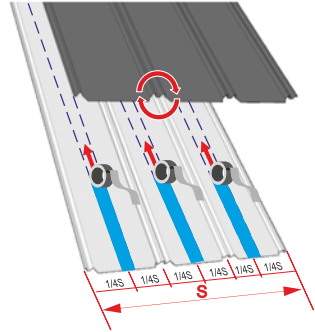
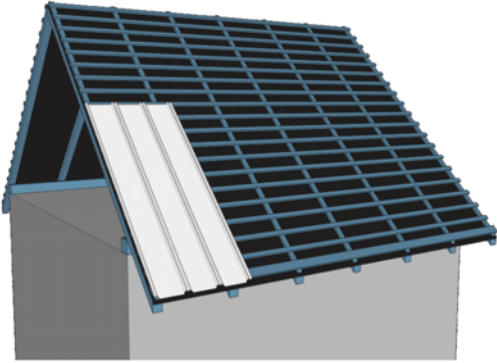

Рекомендації з монтажу фальц-настилу

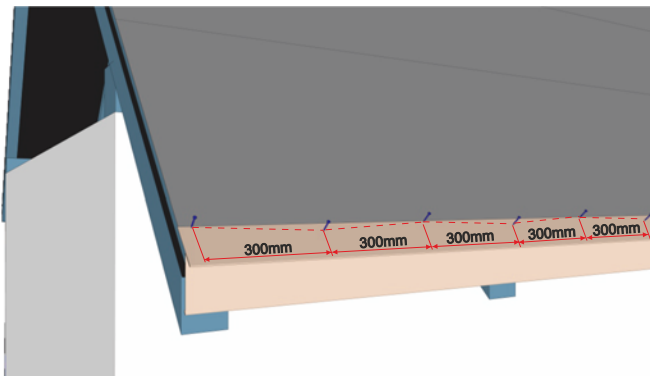
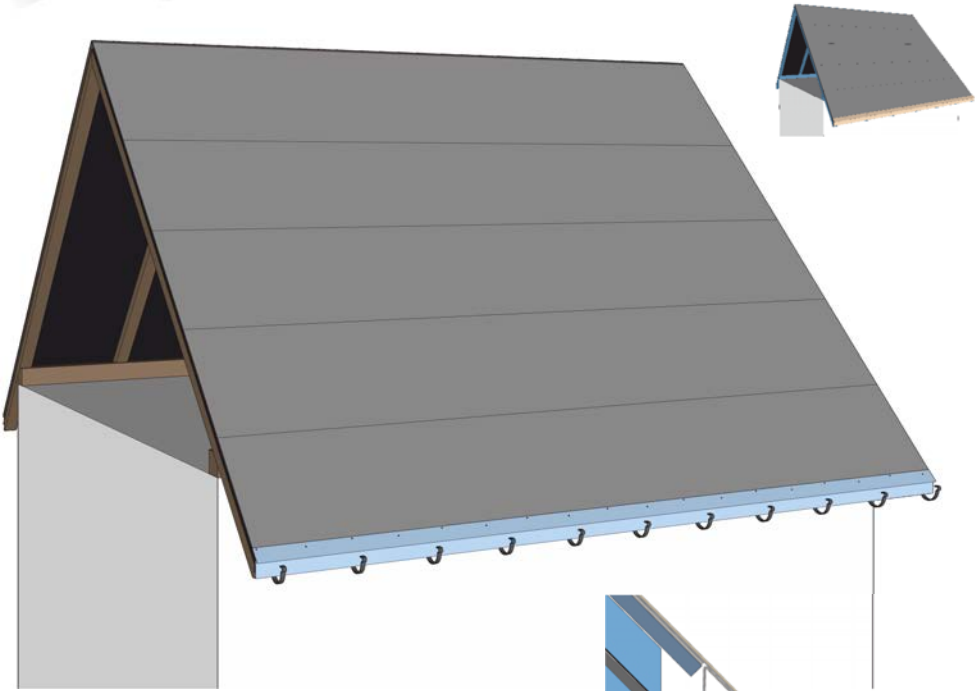

Рекомендації з монтажу фальц-настилу

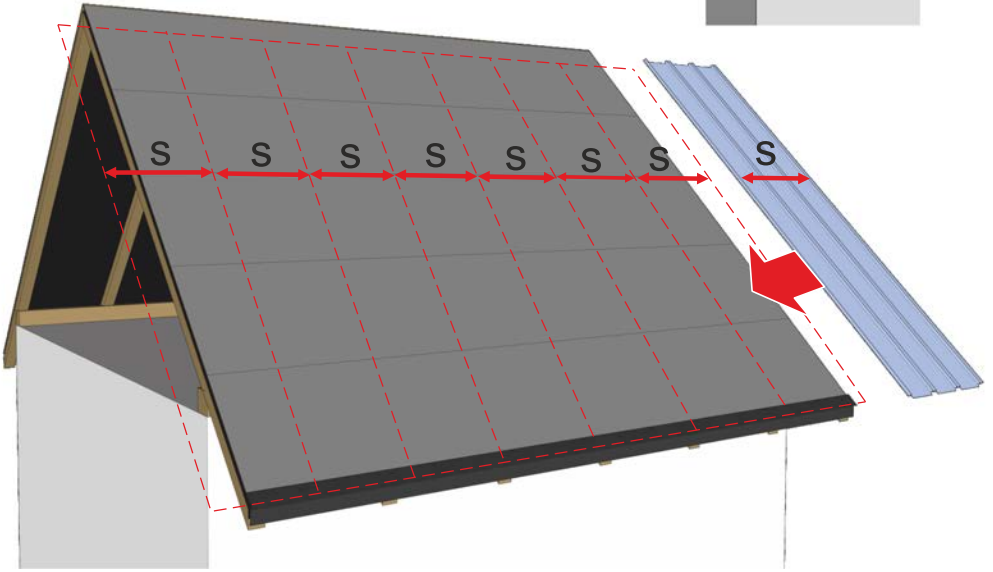
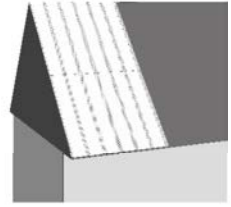

X=Y

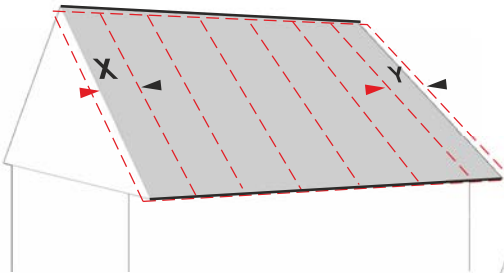

~~**X≠Y**~~

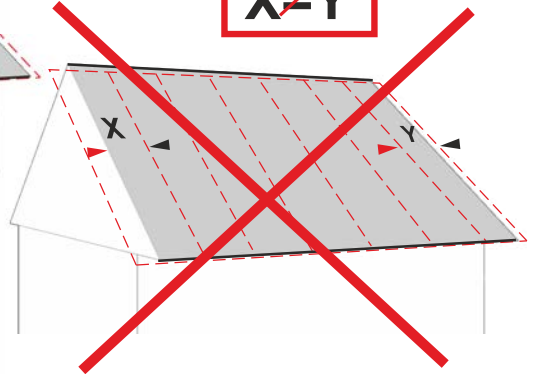

Рекомендації з монтажу фальц-настилу

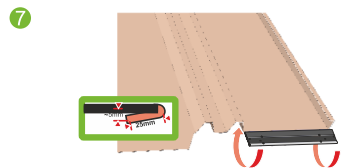
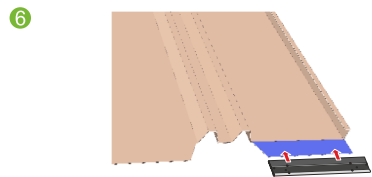
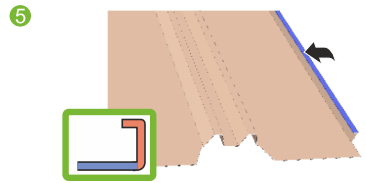
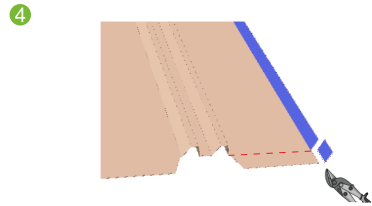
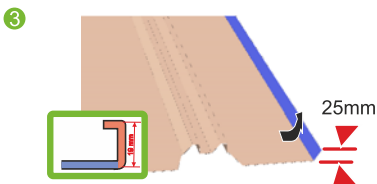
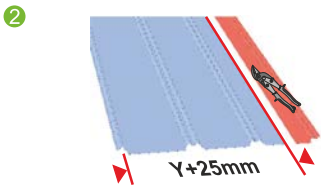
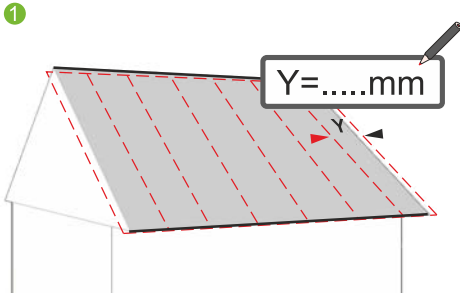
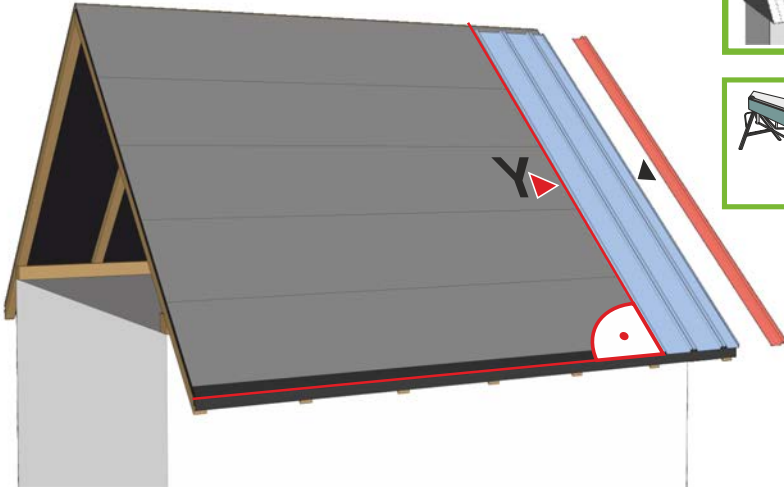

Рекомендації з монтажу фальц-настилу

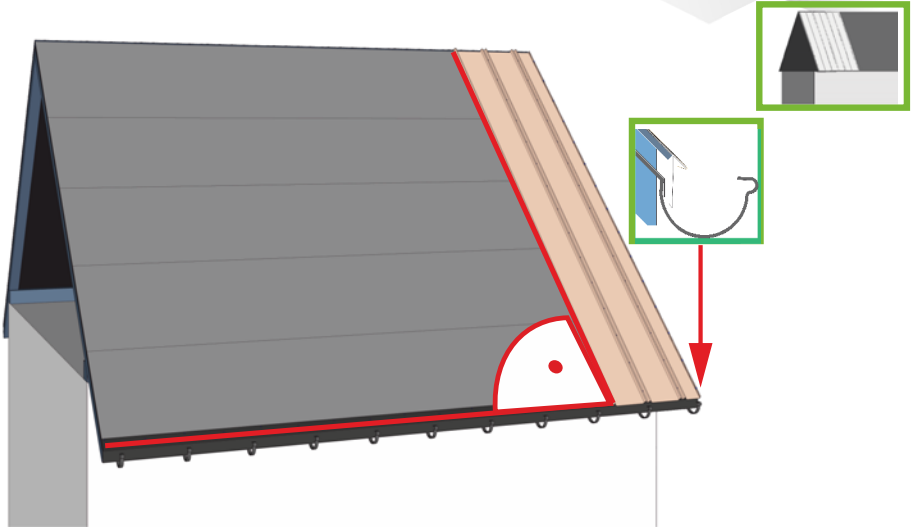

1

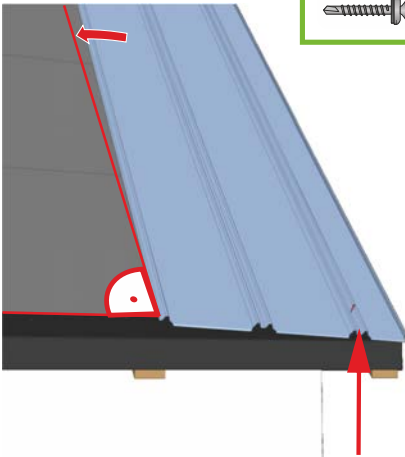

2

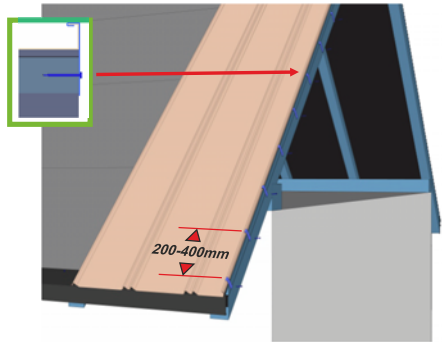

3

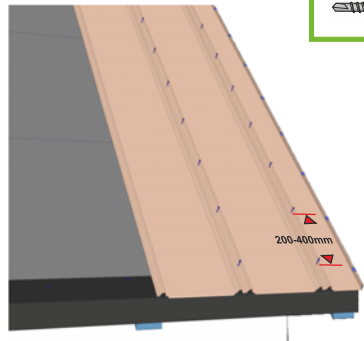

Рекомендації з монтажу фальц-настилу

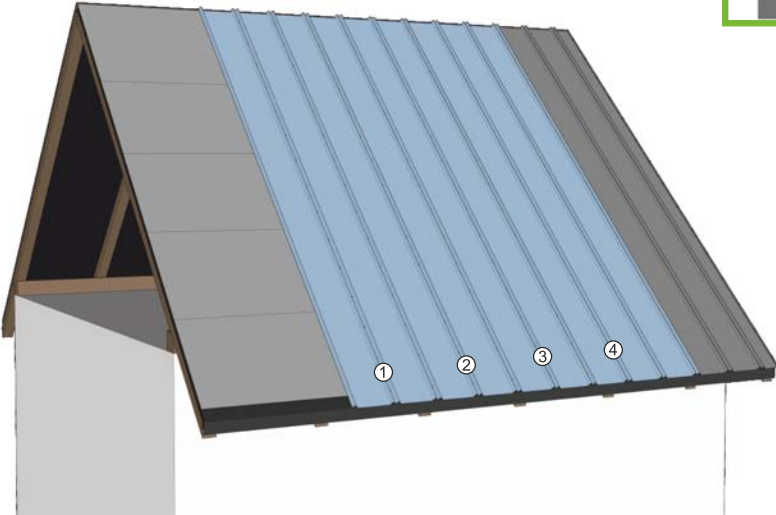

1

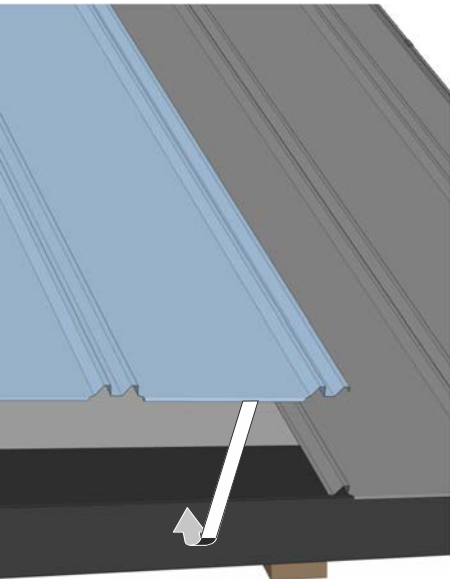

2

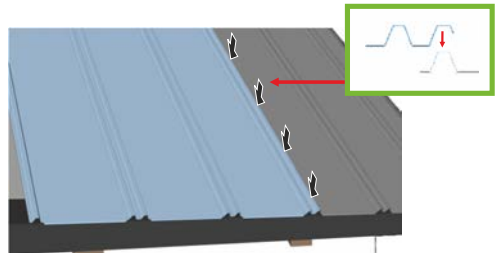

3

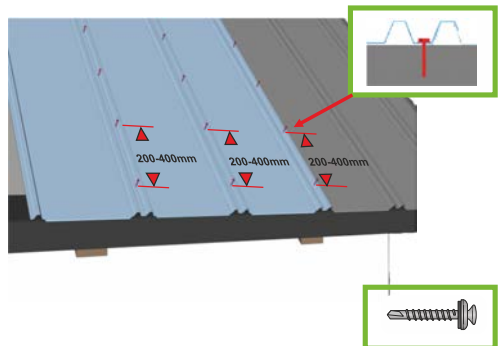

Рекомендації з монтажу фальц-настилу

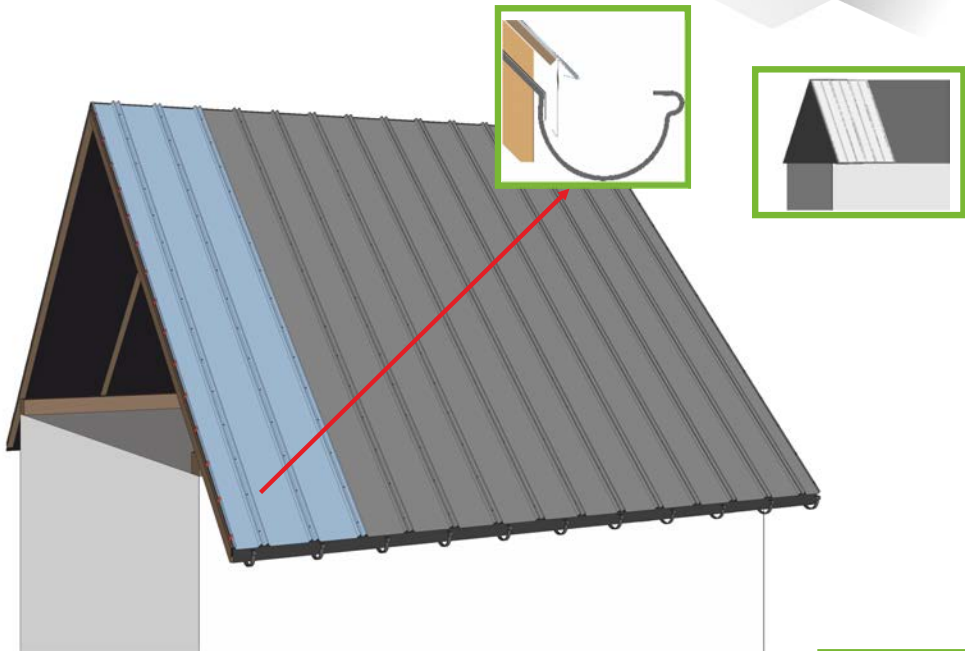

1

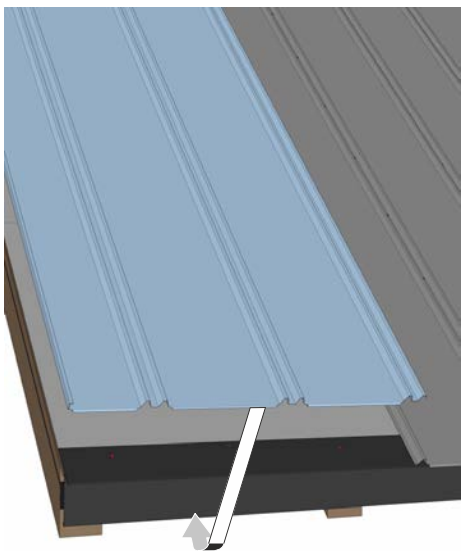

2

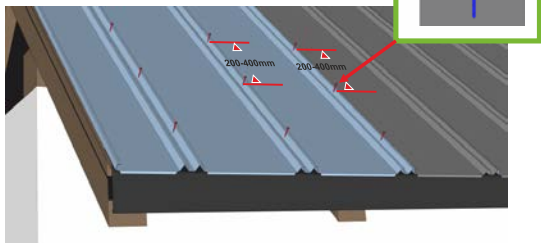

3

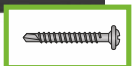
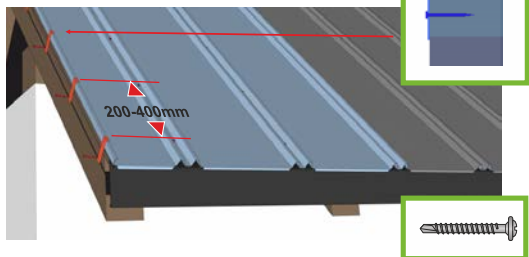

Рекомендації з монтажу фальц-настилу

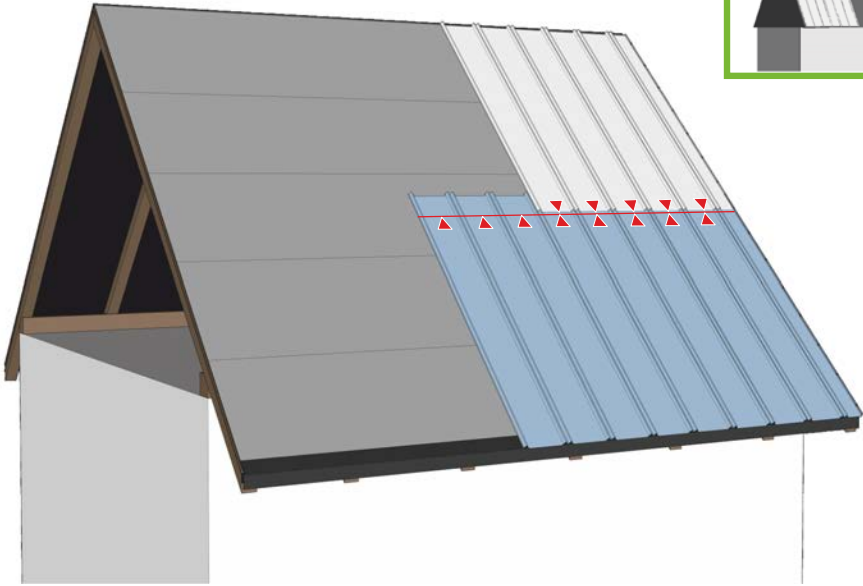

1

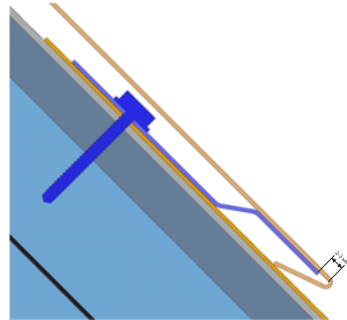
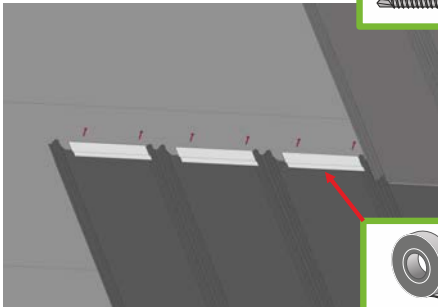

2

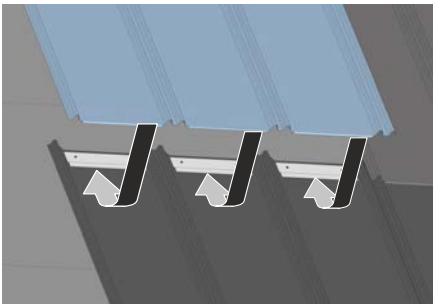

3

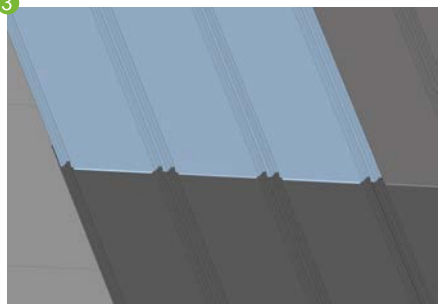

Рекомендації з монтажу фальц-настилу

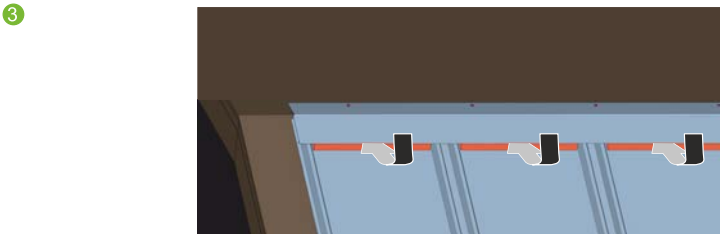
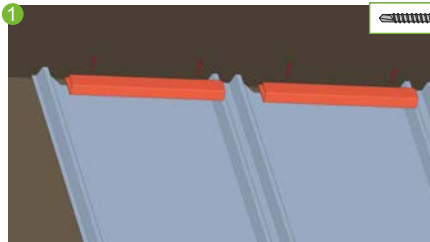
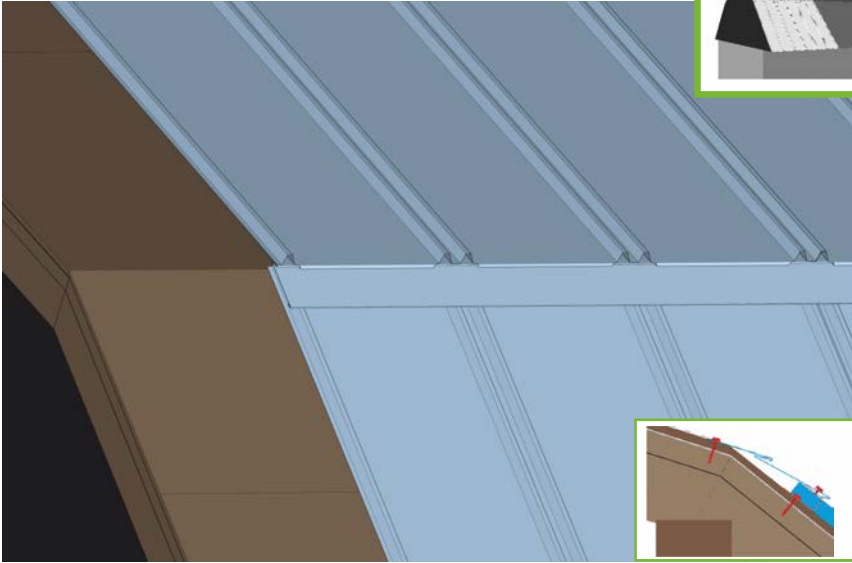
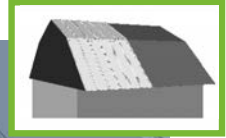

Рекомендації з монтажу фальц-настилу

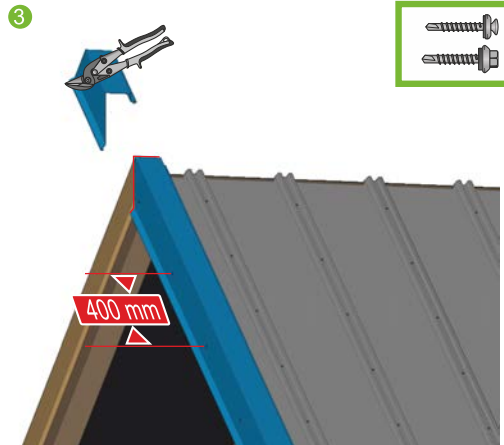
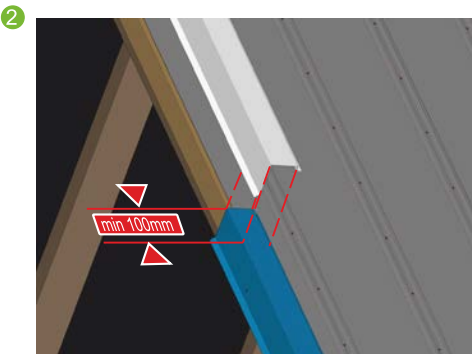
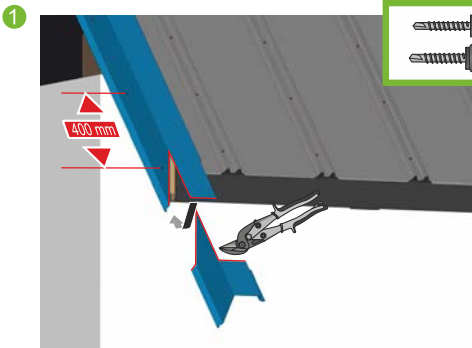
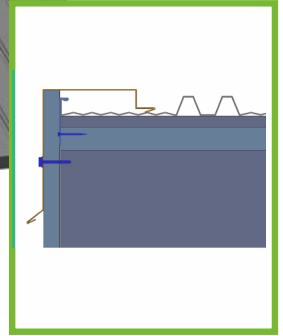
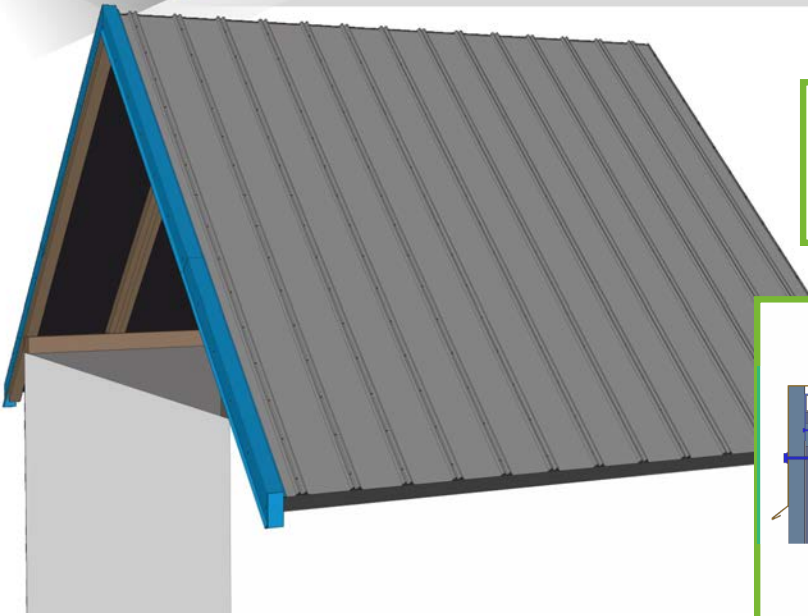

Рекомендації з монтажу фальц-настилу

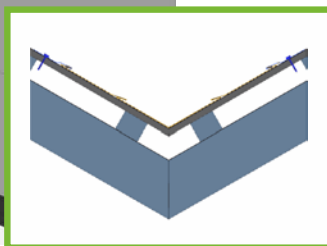
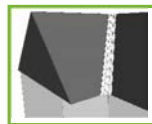
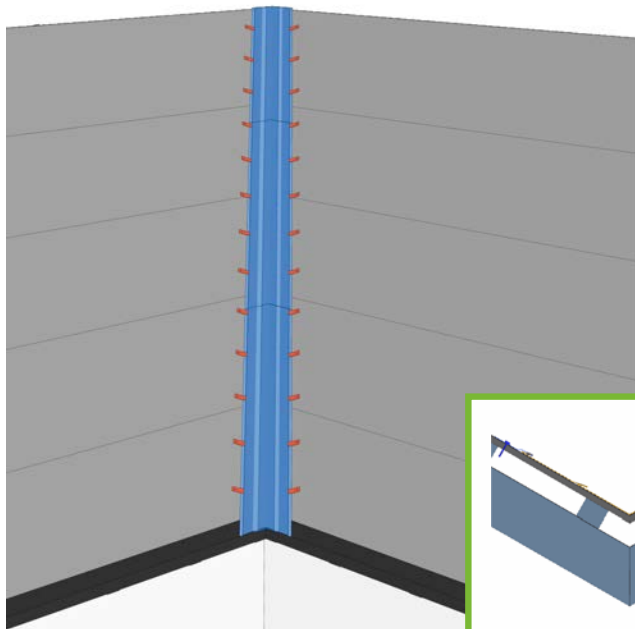

1

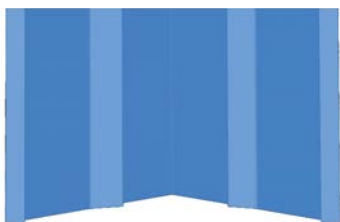

2

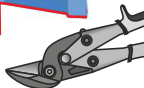
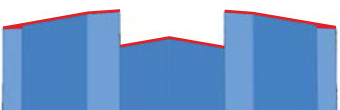
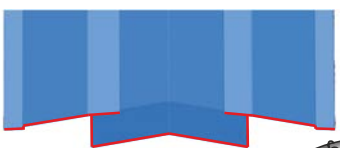

3

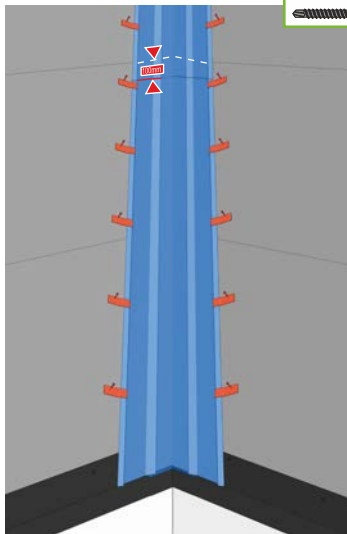

Рекомендації з монтажу фальц-настилу

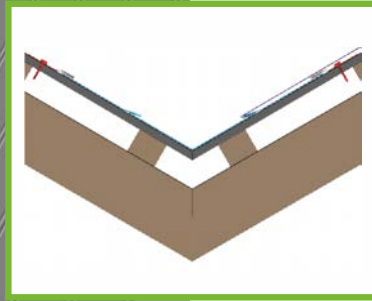
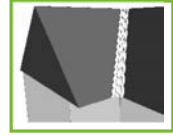
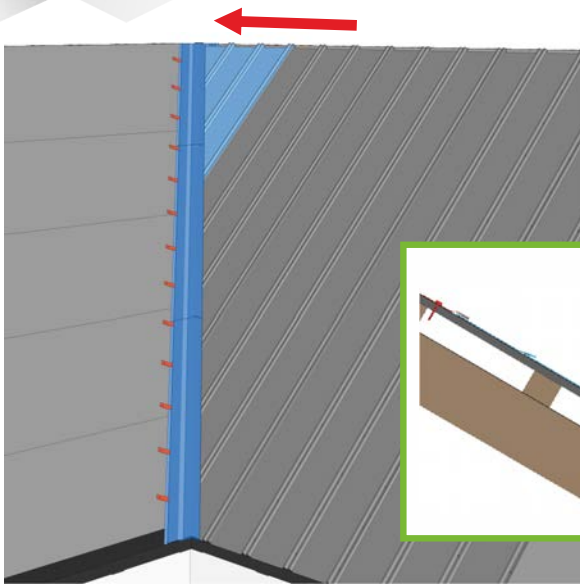

1

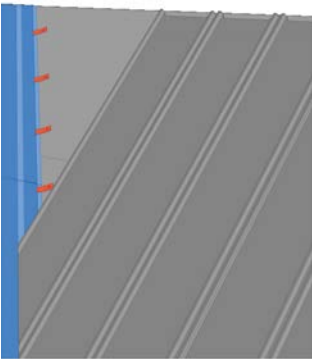

2

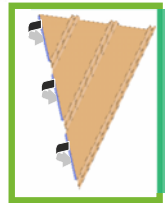
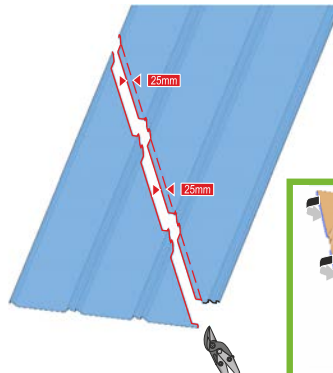

3

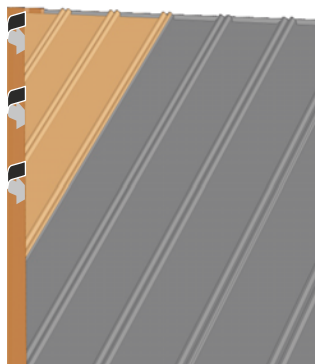

Рекомендації з монтажу фальц-настилу

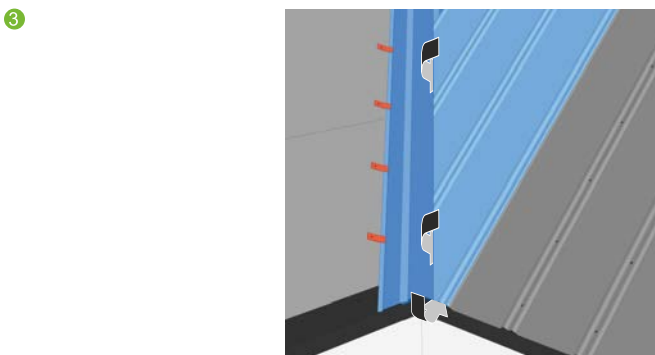
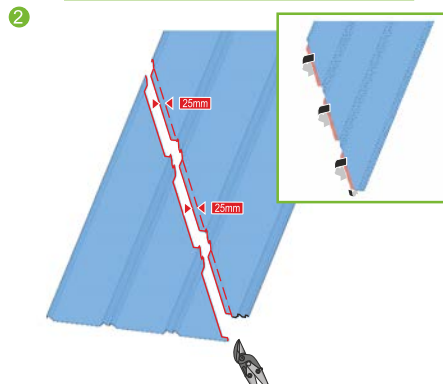
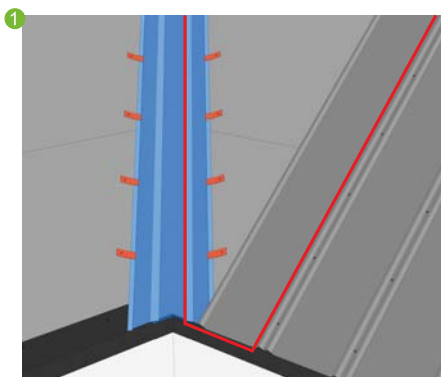
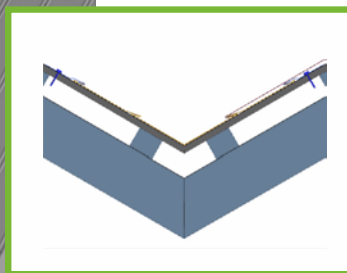
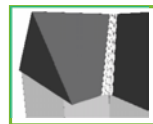
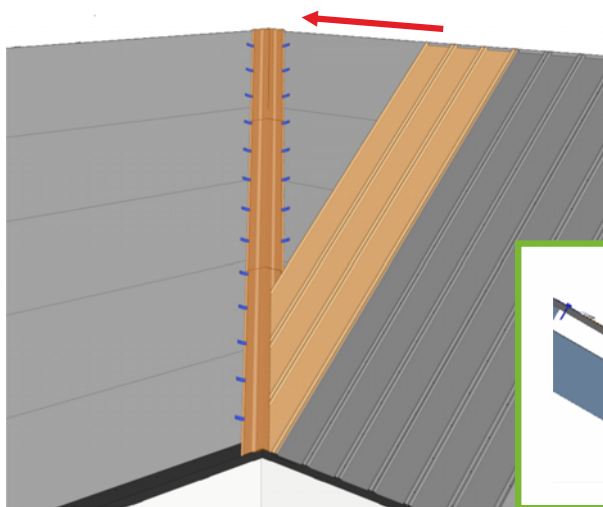

Рекомендації з монтажу фальц-настилу

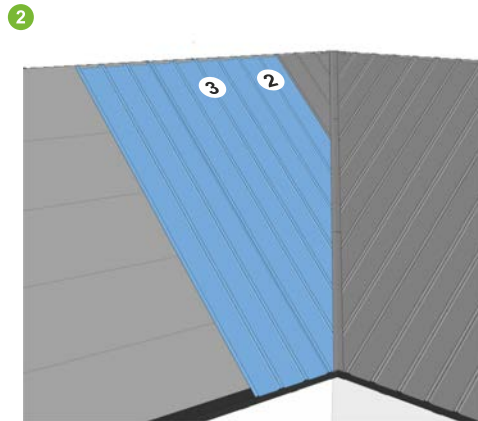
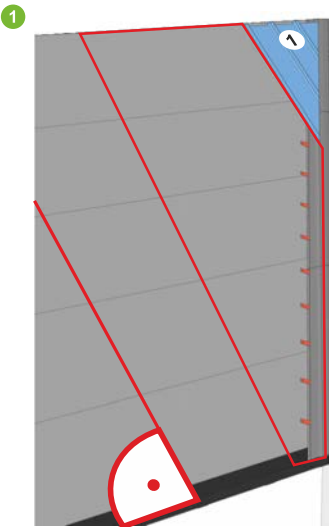
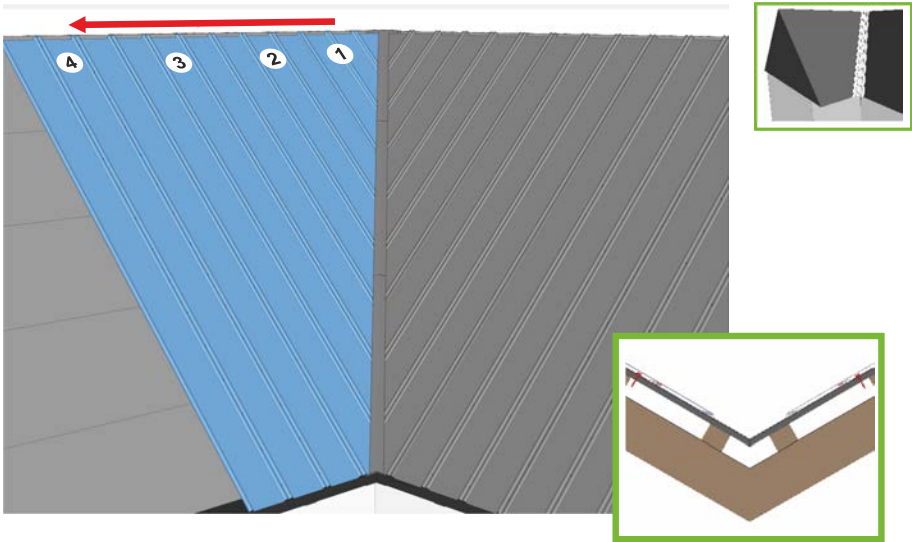

Рекомендації з монтажу фальц-настилу

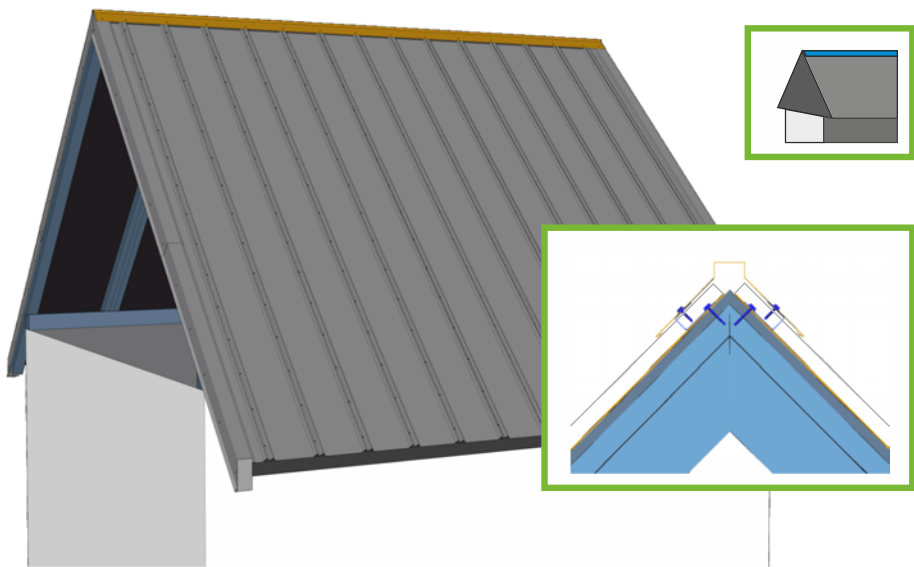

1

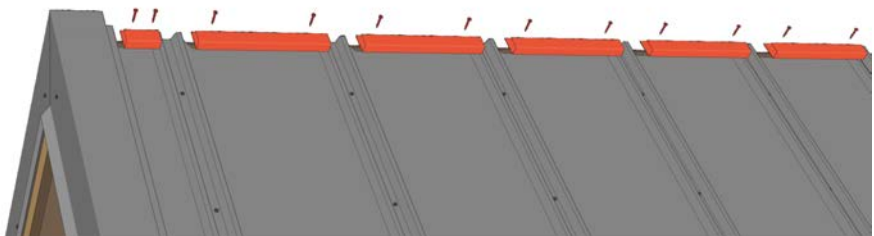

2

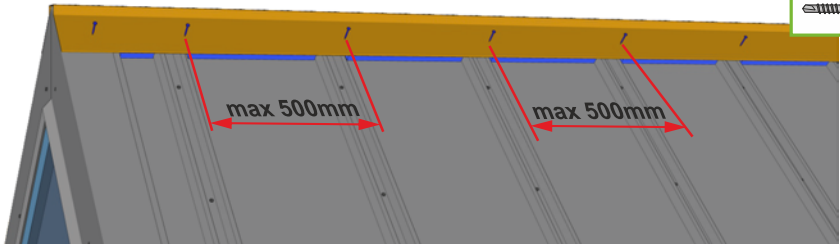

Рекомендації з монтажу фальц-настилу

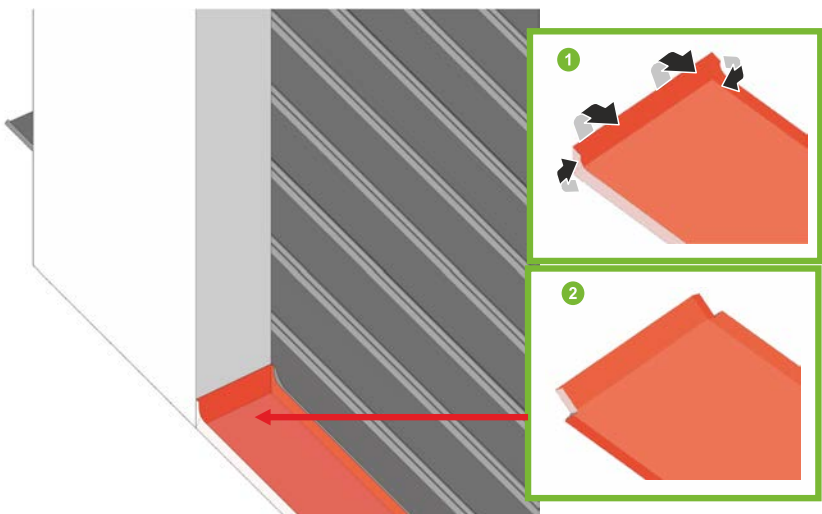
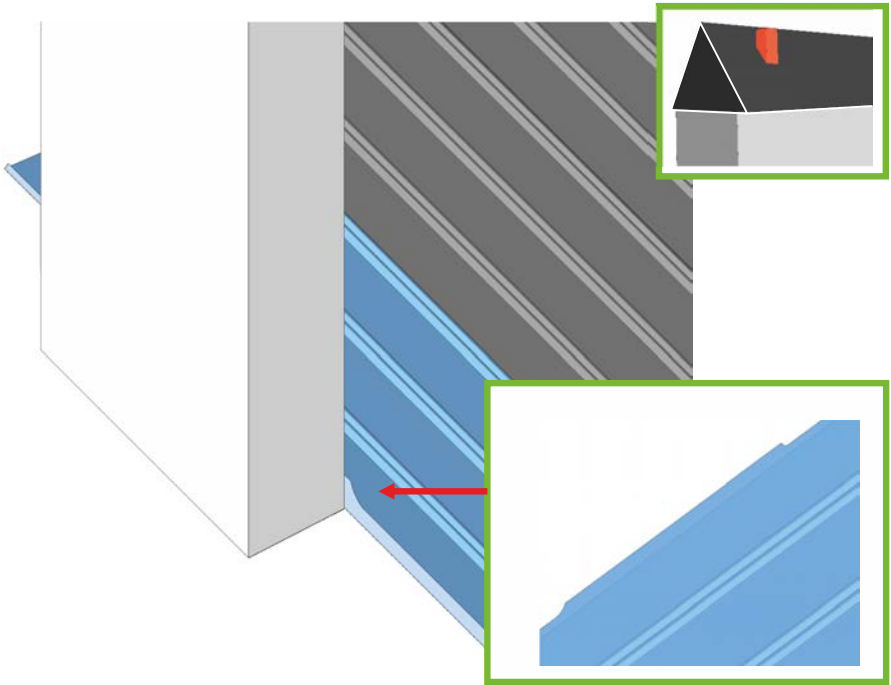

Рекомендації з монтажу фальц-настилу

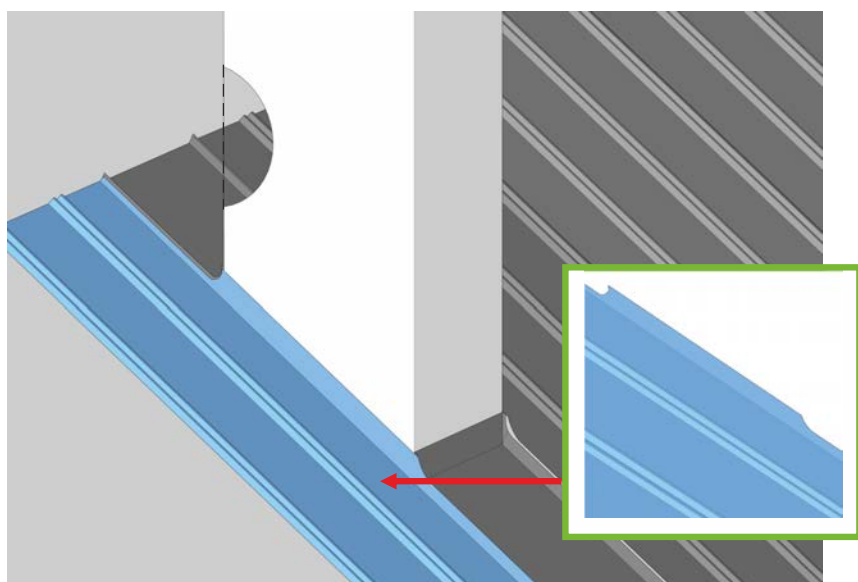
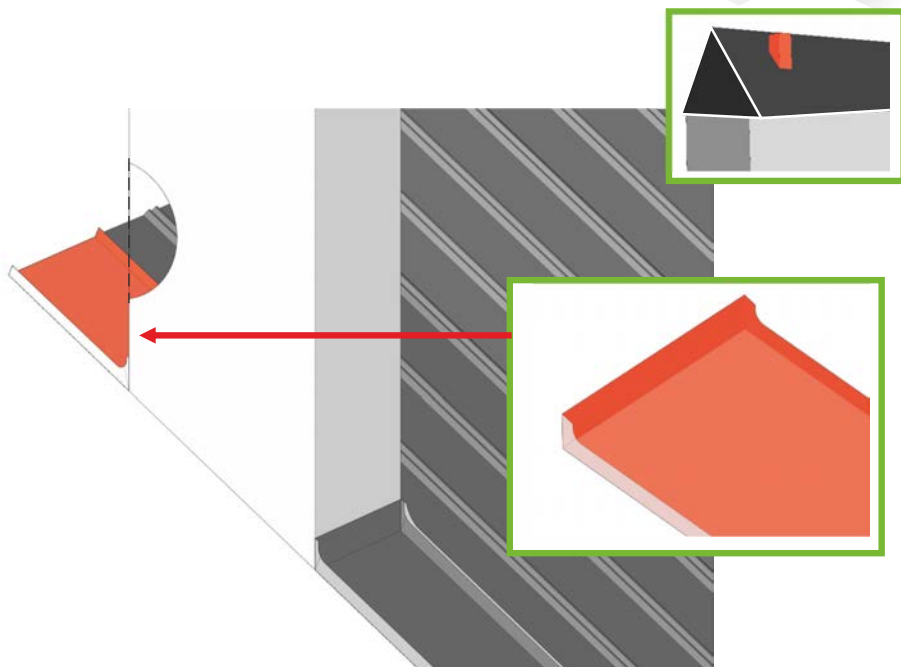

Рекомендації з монтажу фальц-настилу

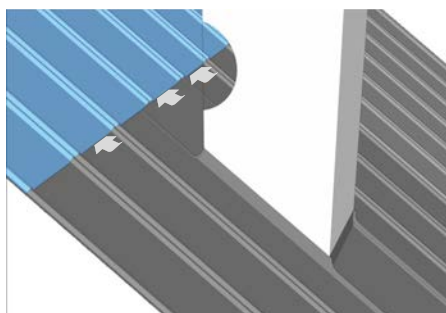
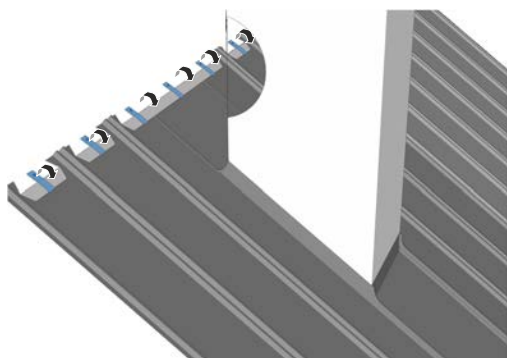
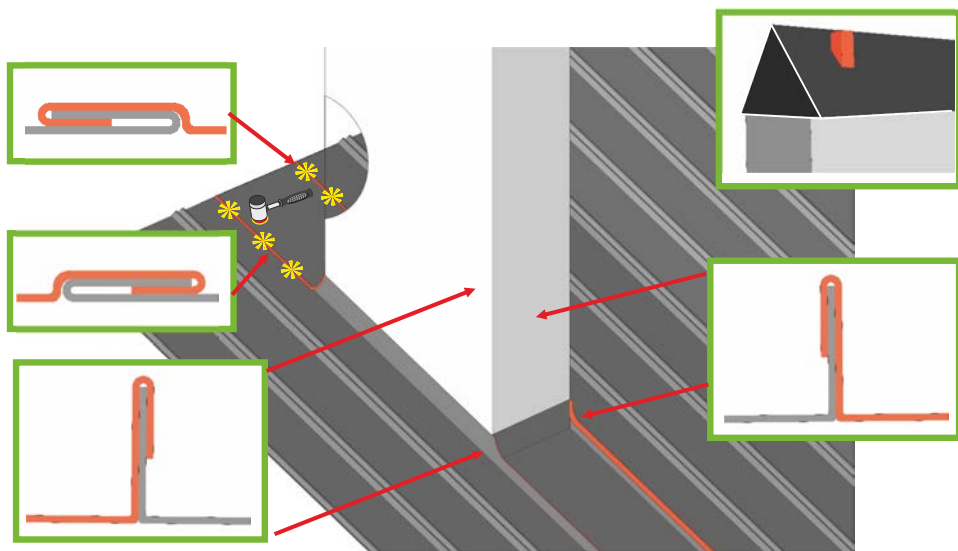



 **(097) 067 99 99**

   **tile.ua**

